

-/T

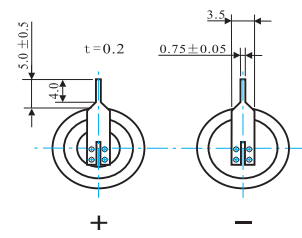

-/2PT

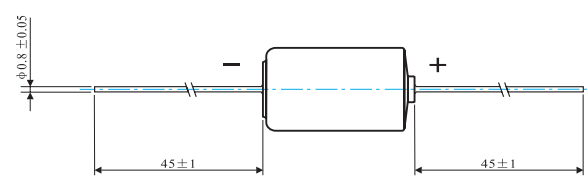

-/P

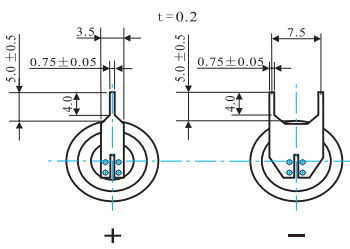

-/3PT

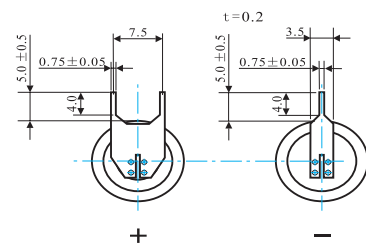

-/3TP

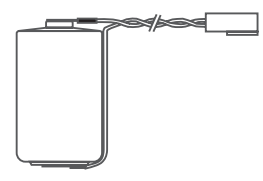

Connector Type1

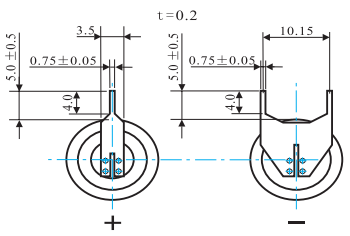

-/3PF

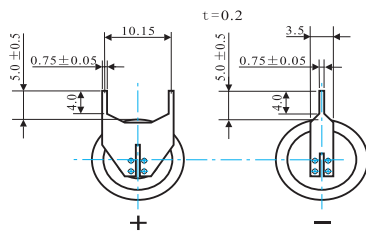

-/3FP

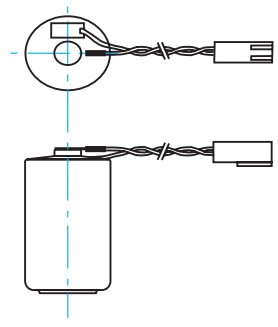

Connector Type2

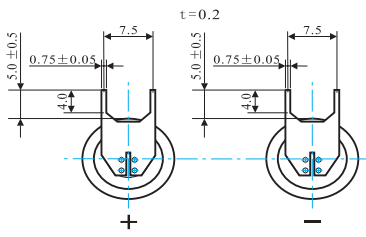

-/4PT

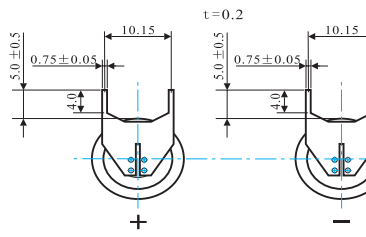

-/4PF

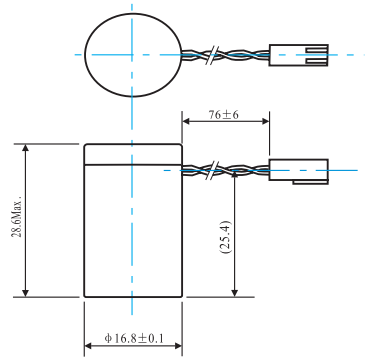

Case Type